



EX7000

User's Manual

Index

1. Introduction	3
2. About this Product	3
3. Definitions	4
4. Safety	4
5. Description Of symbols	5
6. Electrical Specifications	7
7. Environmental Specifications	8
8. Installation	9
9. Accessories	10
10. Operation	16
11. Advance feature	25
12. Maintenance & Cleaning	26
13. Warranty & Service	30

1. INTRODUCTION

About this User Manual

This user manual contains instructions for the proper and safe use of the EX7000 Bed, and for patient & user safety and comfort, which must be strictly followed.

This User Manual must be read and followed by every person using or handling this Bed. In case of any query, Kindly contact Midmark India Pvt. Ltd.

2. ABOUT THIS PRODUCT

- These beds are a non-invasive medical device used for resting and treatment of the patients by medical/paramedical / hospital personnel to help and support the patient in diagnosis, prevention, monitoring, treatment, or alleviation of the disease.
- These beds are for patient support and patient rest facility which helps medical personnel in carrying out their medical procedures comfortably, minimizing the risks while moving and handling the patient.
- These beds are manufactured and supplied in non-sterile conditions for use in the normal hospital environment.
- These beds are electrically operated for certain profiling movements to provide clinical positions with the help of patient and caregiver friendly handset and digital attendant control. These Beds are supported with a Battery Backup.
- These beds are not diagnostic, measuring, monitoring or a therapeutic device or we say that it can prevent or alleviate disease.



- These beds are also useful for intensive care, critical care in hospitals, and nursing homes.

EX7000 Bed Features



Please refer to the EX7000 catalogue for the salient features of this product.

Technical Data



Please refer to the EX7000 catalogue for the technical data of this product.

Add – On Accessories

Please refer to the EX7000 catalogue for various accessories available and compatible

with this product.

3. DEFINITIONS

Operator

The operator is the person appointed by the owner (i.e. clinic, hospital management, etc.) who will be responsible for the safe operation of this Bed.

User

A user is a person who can assess the clinical condition of the patient e.g. specialist medical personnel, doctors, nursing staff, attendants, etc. Based on their training experience or through the instructions, they are entitled to operate the Bed on their responsibility or to carry out work on it and can recognize and control possible risks to the patient as well as the Bed.

Patient

A patient is a person who is ill, infirm, disabled, or in need of care & occupying this Bed. Each time the Bed is allotted to a new patient it is recommended that the patient is instructed by the operator or the user about the functions important for his/her comfort and safety.

4. SAFETY

In this User Manual, the following safety symbols are used.



Danger: This symbol will appear wherever safety instructions are designed to protect people from physical harm. The symbol stands for imminent danger of death or serious injury.



Caution: This symbol will appear where situations are described, which might be dangerous, and which might inflict slight injuries.



Electrical Hazard: This symbol will appear when a life-threatening hazard or hazardous condition is likely to occur.

















Advice: This symbol will appear in front of additional helpful pieces of advice.



A dot in front of the text implies the action that is required to be taken.

5. DESCRIPTION OF SYMBOLS: -

Symbol & Title	Definition
	Catalog number
	Batch/lot code
	Caution
	Consult instructions for use Follow operating instructions
	Manufacturer and date of manufacture
	In-house use
	Working temperature limits
	Working humidity level
	Do not throw in dustbin
	Medical device
	Adults only
	Refer to instructions for use
	CE logo
	Type 2 parts applied

Safety Instructions

- Always use Midmark India accessories that have been designed and approved for use with the Bed.
- Ensure that the Bed is assembled and installed in accordance with the instructions given in this User Manual.
- Restrict child visitors without proper attendants. Supervision is necessary to avoid any mishap due to the unintended movement of the Bed.
- Persons with reduced physical or mental abilities & children must not be allowed to use & handle the Bed without proper supervision.
- Do not allow any visitor to sit on the bed, as it may cause overloading. (Refer section --- Operation)
- Accessories or any devices used along with the Bed should be as per its intended use specified and approved by Midmark India.
- The Bed should always be kept and used in a normal indoor hospital environment.
- The Bed is not suitable for use in the presence of a flammable anesthetic mixture with air or with oxygen or nitrous oxide. It may damage the Electro-Mechanical Control System.
- Always use a mattress of the correct size and type. Before operating the Bed, make sure that the patient is safely positioned to avoid entrapment or imbalance.
- Do not keep any articles on the Base Frame Cover of the Bed. It can damage the linkages and electrical components.
- A notice to the user and/or patient that any serious incident that has occurred in relation to the device should be reported to the manufacturer and the competent authority of the Member State in which the user and/or patient is established.
- Keep the User Manual handy with the Operator/User for ready reference.



Keep some gap between walls and bed while in a stationary position and while moving from one place to another.



The use of water on the mattress is prohibited.

Electrical Safety Points

When the Bed is connected to 230V / 15A (or as per country-specific) main supply-

Connecting more than one plug to the three-pin mains socket can cause electrical overload and damage the control system of the Bed.

- AC power supply exceeding 230V or sudden spikes or lack of proper earthing can be hazardous to User / Patient, as well as can cause damage to the Bed and property.
- Ensure stabilized and properly earthed input power supply for the equipment. Also, ensure the polarity of the mains socket is as per Standard and matches with the mains plug.
- Inspect all the wires and cables for any cuts, cracks, and damages at regular intervals.

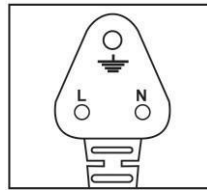

6. ELECTRICAL SPECIFICATIONS

Mains power supply	Nominal 240 VAC
Operating Range with Battery	(150 VAC to 300VAC without battery) (90 VAC to 300VAC with battery)
	50 Hz \pm 5 Hz
Protection Voltage	300 V to 450 V for 230 VAC system
Mode of operation	10% (2min. in use /18 min. not in use)
Power consumption idle mode without battery	5W
Power consumption idle mode with battery	10W
Power consumption at maximum load	300 Wmax.
Mains Fuse DC Bus Fuse	2A fast blow for mains (external) 10A fast blow fuse (internal)
Protection Class	Class I
Degree of Shock Protection	Type B

Battery Charger

- Battery Charger
- Suitable to charge 1.3AhX 2 batteries.
- Reverse polarity protection
- Spark free connection
- Short circuit protected output.
- Very minimal battery consumption at idle state, to enhance standby time.
- Battery overcharging protection.
- Battery low or dip discharge protection

7. ENVIRONMENTAL SPECIFICATIONS

Usage, Storage and Transport

Temperature	-10° C to 50°C
Relative Humidity	0% to 95% non-condensing
Atmospheric Pressure	800 to 1060 hPa
Altitude	< 200Qm

Storage /Transport

Temperature -	10°C to 50°C
Relative Humidity	0% to 95% noncondensing
Atmospheric Pressure	800 to 1060 hPa
Altitude	< 2000m
Protection degree	IP54

8. INSTALLATION



1. Unpack all the components carefully.
2. If the packing is drenched by rain, water, or other liquids, inform this matter to the operator.
3. Each Bed is supplied with the following components as per the packing list:

Rubber Buffer with bush	- 4 Nos.
Polymer Moulded Head and Foot Board	-1 Pair
Miscellaneous items	-1 Packet

4. Prior to connecting the bed to the mains, get the input voltage & earthing tested through a qualified electrician. It is necessary to ensure that all electrical connections are proper and tightened.
5. It is advisable to charge the battery for 24 hours to get the best performance when plugged in for the first time.
6. For using the Embedded panel and ACP (Product Specific) check all the functions by pressing the respective buttons
7. Demonstrate the functions of the Bed to the User / Operator



Notify if any damage has occurred during transportation either to the authorized agent or directly to Midmark India Pvt. Ltd.



Installation of the Bed should be done only by Midmark India trained technicians.

9.ACCESSORIES:

STANDARD ACCESSORIES:

➤ Head & Foot Boards: 0192

- Fix Head and Foot Board by extending the equal forces with both the hands in the bracket.



EX7000

➤ Five Section Metal (MS) Top:

- Place the individual Polypropylene sections of Backrest (Upper), Backrest (Lower), Middle, Upper Leg rest and Lower Leg rest on their respective positions on the Bed top frame as shown in the figure below.



➤ **Urine Bag Holder**

Provision to hold the urine bag on the bed for immovable/critical patients.



ADD ON ACCESSORIES:

➤ **Heavy Duty IV Pole (2 Hook) / (4 Hook)**



Used to hang IV bags for infusion of liquid substances directly into the vein.



Do not overload the IV Pole with more than 20 kgs. Equally distributed on all hooks. Eg: 10 kg on each hook if 2 hook IV pole is used, and 5 kg on each hook if 4 hook IV pole is used.

➤ **SS Lifting Pole**

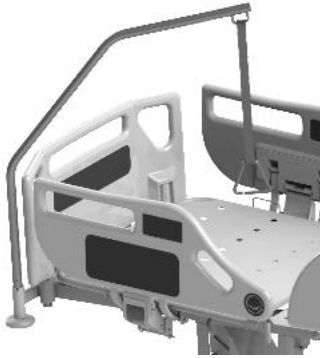

Helps the patient lying on the Bed to lift themselves on their own,

➤ **Moulded Chart Holder**

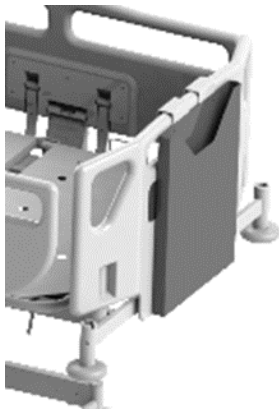

Used for keeping medical reports and charts.

➤ **Orthopedic Traction pulley attachment for trauma cases**



Used in orthopedic treatment physical therapy by hold the handgrip.

➤ **Oxygen Cylinder Cage**



Used to hold the oxygen cylinder when transferring the critical patient.

➤ **ICD bottle holder**



Used to store ICD bottles.



Ensure that the accessories are properly secured and not overloaded to avoid any personal injury or equipment damage.



Use the Bed accessories in accordance with the manufacturer's instructions for patient safety and comfort. Use recommended spares and accessories of suitable design manufactured by "Midmark (India)" to eliminate hazards.

X-Ray Permeable Backrest with Cassette Holder

- The Backrest Support Top in this option is made of the high-pressure laminated sheet which is X-Ray permeable.
- This facility is provided especially for patients who are seriously ill or too weak to stand unsupported and need the X-Ray imaging without being moved out of the bed.
- Beds having with X-Ray Permeable Backrest come factory fitted to the bed, and do not need any special installation.

Procedure to use X-Ray Backrest

- Raise the Backrest to a convenient position.
- Unscrew both the knobs provided at the sides of the Cassette holder.
- Slide the Cassette holder upwards and outwards from its guides.
- Place the X-Ray late on the Cassette holder to its desired position for X-Ray imaging.
- Lock the plate in position by adjusting the levers.
- Insert back the Cassette holder with Plate in its guides.
- Tighten both the knobs provided at sides.
- Adjust the Backrest to facilitate X-Ray imaging.



Only authorized and qualified persons designated by the Operator and having proper training should be allowed to prepare the bed with the patient for X-Ray imaging.

ELECTRICAL CONTROL SYSTEM

The electrical control System of this Bed consists of:

- Four Actuators to facilitate the movement of Back Section, Upper Leg Section, Height, Trendelenburg / Reverse Trendelenburg Tilt.
- User Friendly Handset for achieving various clinical positions.
- Handset (Product Specific) is provided to aid nursing staff for achieving various clinical positions and locking any function in the embedded panel to avoid any unintentional misuse of the Bed by patient.
- A controller unit is located below the main frame of the Bed to which all the other electrical components such as Handset and Night lamp are connected through Junction Box. A battery box containing two batteries (optional) (for power back up in an emergency and during the power failures) is provided below the main frame of the Bed and is directly connected to the controller.

10. OPERATION

- Before putting the Bed Into use for the first time ensure that all the transport securing devices and packing film are removed.
- Clean and disinfect the Bed prior the first-time use.
- The Bed should be used on a flat floor.
- The force required to move the Bed from one place to another with/without patient may vary depending on the flooring conditions.
- Check it all the operations are functioning properly.
- This Bed should be operated only by an authorized and trained person who knows its operation.



Do not stretch/ extend the power supply Cord from Its plug.

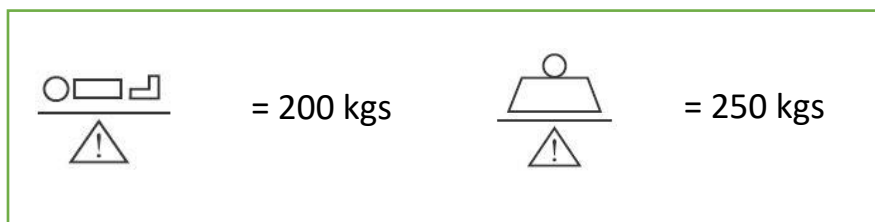

Do not load the Bed more than the Safe Working Load as mentioned above.

MECHANICAL ADJUSTMENTS

Operation of the Central Locking

The Central Locking Castors are provided with a lever which has got three positions.

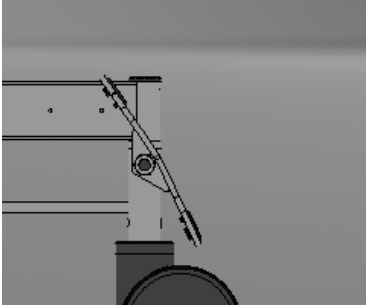

When pushing the foot rod downwards, all Castors completely get locked, and the Bed does not move at all.

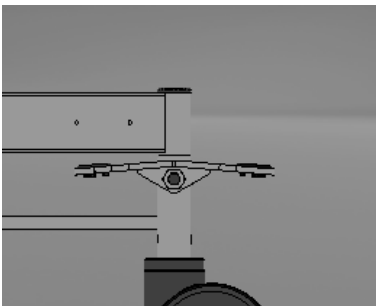

When pushing the foot rod to its middle position, all the Castors are free and can be moved to any position.

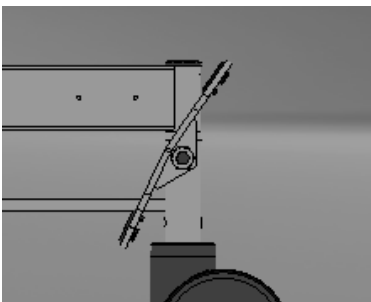

When pushing the foot rod to its upper most position, the steering Castors gets locked to swivel which help the Bed to move in a straight direction.

Lower Leg Section

Ratchet mechanism to move the lower leg section manually to attain DVT and knee break position with the help of SS ratchet handle.

To Raise Leg Section (Lower part) manually –

- Firmly hold and lift the Leg Section (Lower part) with one hand.
- With the other hand hold the Ratchet Handle to the required inclination.
- Place the ratchet Handle in the desired ratchet Notch to lock the position.
- Make the patient comfortable by readjusting his position on the Bed.



To Lower Leg Section (Lower part) manually –

- Firmly hold the Leg Section (Lower part) with one hand.
- Pullout the ratchet handle from the ratchet notch to unlock the position.
- Carefully place the Leg Section (Lower Part) on the Mainframe
- Ensure the bed is flat after lowering the leg section.



Always observe the correct adjustment sequence.



Care should be taken to avoid fingers and hand getting entrapped between the Ratchet and the top frame.

CPR Release Handle

Emergency lowering of the Back Section using CPR Release Handle

The CPR Release Handle is to be used to bring the Back Rest to its flat position in case of emergency or power failure.

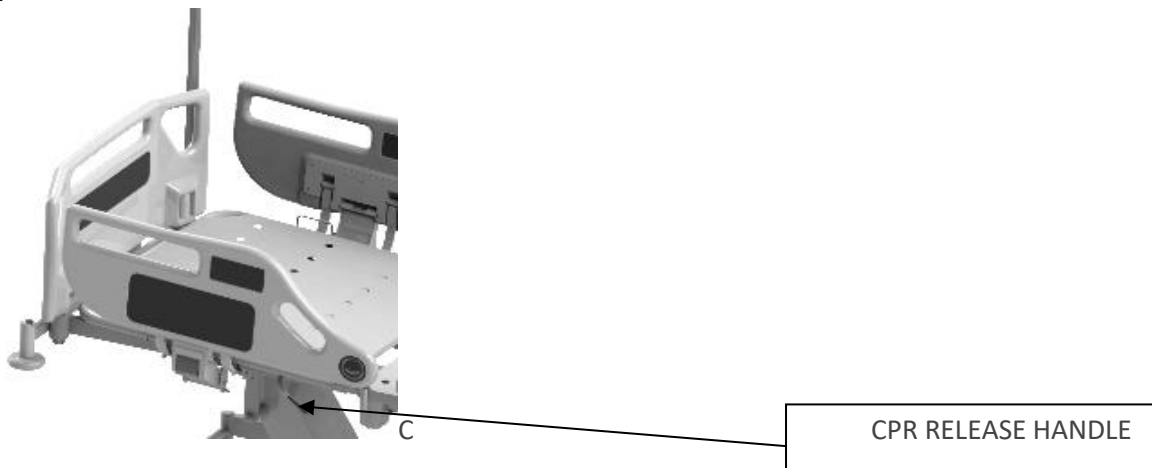

Procedure for Operating CPR Lever manually

- Hold the Back Section with one hand while operating CPR Release Handle.
- With one hand pull the operating lever (CPR Release Handle) so that the Back Section can be lowered. The Back Section Actuator is locked in this process.
- The Back Section does not stay in its flat position until the CPR Handle is released.
- Once the flat position is achieved. release the CPR Release Handle.
- CPR can also be achieved by long pressing CPR button on handset, till bed becomes flat and height lowers down.



Since the Back Section is designed for motorized adjustment, manual CPR should be used only in case of emergency.



A continuous manual adjustment may damage the Actuator. As the Backrest can fall quickly, keep hands clear to avoid trapping.

Head & Foot Boards



- The Head and Footboards are located at the head and foot end of the Bed frame.
- The Head and Foot Board can be removed or attached in a single step by extending equal force with both the hands in the bracket by ensuring the proper matching of the brackets with the board holder fitted in the mainframe.
- The Head and Foot Boards can be removed for ease of access to the patient from the head and foot side.



Do not hang any heavy items on the Head and Foot Boards.

Safety Side Railings (Product Specific)

To use the Safety Side Railings —



0380 Railing





- Immobilize the Bed.
- To raise the Railing, pull it to the top position until it gets locked.
- To release/lower the Safety Side Railing, ensure that there are no obstacles in the path of the railing.
- Lift the lever and push the Safety Side Railing down to its end position.
- Always keep the Safety Side Railing in the raised condition when moving the patient with the Bed. Do not use the Safety Side Railing to lift or move the Bed.
- Safety Side Railings must only be used with a mattress of the correct size and which is approved for use with the Bed.
- To prevent the patient from falling, ensure that the Safety Side Railings are in the raised position.
- The clinically qualified person responsible should consider the age, size, and condition of the patient before allowing the use of the Safety Side Railings.
- Other manufacturer's Safety Side Railings are not compatible with these Beds.
- Please take care of your fingers and hands while operating the Safety Side Railings.



Safety side rails should be fitted and properly secured by a trained technician.



Always use the safety rails with the mattress of the correct size, which is approved for use with this bed for the safety of the patient.

-  Do not use the safety side rails to move or lift the bed.
-  Although the safety side railings have been designed to reduce the risk of patient injury, the potential exists for patient entrapment, particularly in agitated or disoriented patients, patients who have a cognitive disability or have uncontrolled body movement as well as patients who lack the physical strength to extract themselves if they get entrapped.
-  Users should carefully evaluate the need for safety side rails and periodically check patients in ill accordance with facility protocols for safe positioning.
-  The Safety Side Railings should always be in the raised position when attaining lowest height position or when attaining Trendelenburg / Reverse Trendelenburg tilt positions.
-  If these safety measures are not observed, injuries can be caused to hands, knees, fingers, feet, legs or other body parts of the patient due to unintended and unintentional entrapment. In children or weak patients who are less than 146 cms tall, non-observance of these guidelines may even lead to death.

Electrical Adjustments











1) **Power ON/OFF Button: Press the - Power button to put the system ON.**

With this button the system is alive. Press again the power button to put the system OFF. Once you OFF the system, side rail Embedded system/ Handset will also turn OFF.

2) **Feature Lock Button:** Press the feature lock button to lock the required clinical positions at any given time. Once you lock any clinical positions and if you try to change it, the LED light placed at the top right of the lock feature button will blink indicating that the feature is locked by the user. Once the feature is locked, the same feature cannot be accessed from the embedded system/ Handset. Press again the feature lock button to unlock the feature.

3) **Emergency Head down button:** Single continuously press the button to lower the head section of the bed for emergency cases.

4) **CPR:** Single continuous press the button will enable the bed to become flat and the height of the bed goes to its lowest for nursing staff to perform emergency activities.

- 5) **Back Section Buttons:** Press  button to raise the backrest section.  Press button to lower the backrest section.
- 6) **Upper Leg Section Buttons:** Press  button to raise the upper leg section. Press  button to lower the upper leg section.
- 7) **Auto-Contour Buttons:** Press  button to raise back section and upper leg section simultaneously. Press  button to lower back section and upper leg section.
- 8) **Bed Height Buttons:** Press  button to raise the height of bed.  Press button to lower the height of bed.
- 9) **Trendelenburg/Reverse Trendelenburg Buttons:** Press  button to lower the leg section (Reverse Trendelenburg).  Press button to lower the head section.

Using Handset for EX7000

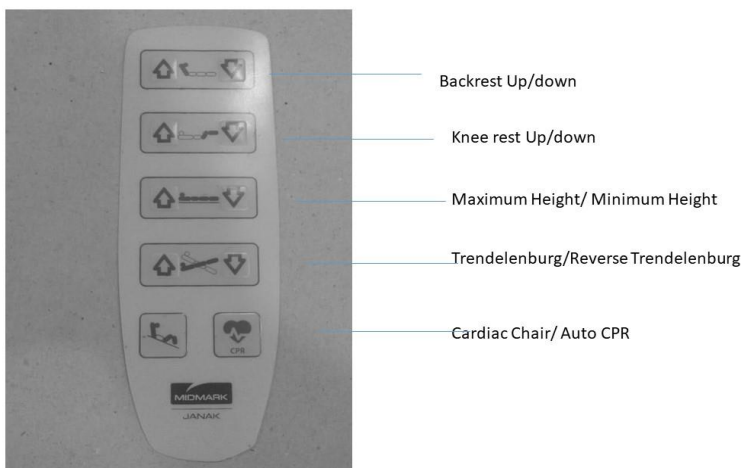

Battery

The Bed is equipped with battery to allow emergency operation of the electric drive system. This ensures that all the power requirements can still be supplied in the event of power failure. The battery also has inbuilt fuse protection for the safety of battery as well as users.

Battery Indicators on Embedded Panels (PRODUCT SPECIFIC)-

- Green indicator of power 'ON' button on embedded panels shows that the control elements are running on the main supply.
- Green indicator of battery symbol on embedded panels shows that the control elements are running on battery and battery is at full charge condition.
- Orange indicator of battery symbol indicates that control elements are running on the battery and battery is at medium charge condition.
- Red indicator indicates that the battery is fully discharged, and no further function is possible on battery.



It is necessary to fully charge the battery at least once a month, especially when the Bed has not been in use for a long time. Otherwise, the battery could get permanently discharged and/or damaged.



Always keep the Bed in charging condition for any emergency use.



Always keep the Bed connected to the main supply to get a fully charged battery.



Operations of the Bed on battery should be only as per its duty cycle (refer Electrical Specifications given above)



Batteries in the Bed may emit hydrogen gas. So do not bring fire or a heated object close to the Product.



With due consideration to environmental limitations, materials used to make the device are not affected by contact with any biochemicals or biowaste. When used as per its intended purpose, all materials used in the product and accessories do not facilitate any breeding or growth of bio-contaminants on their own.

11. ADVANCED FEATURE

PATIENT WEIGHING SYSTEM

The controls for the weighing system are located on the middle main frame end split side.

INITIALISATION

After connecting the bed to the electricity supply, the weighing system must be initialized as follow:

1. place the mattress, bed linen and all necessary accessories on the bed. The patient must be on the bed at this point.
2. Press the **Zero** button once.
3. After a few seconds the display will read 0.0.
4. The bed cannot be re-zeroed once a patient is on the bed. Use the auto compensation feature if adding or removing items from the bed such as linen or accessories.

ACCURACY: The weighing system is very sensitive and can be affected by a few external Factors. For best performance, observe the following precautions.

- Ensure the bed is on flat, level surface.
- Ensure the transport locking bolts and washers have been removed before use.
- Position the bed so that it is clear of obstructions, e.g., walls, furniture, cables, and curtains.
- Ensure the patient is fully on the mattress during weighing.
- While weighing is taking place, the patient should keep as still as possible and other should keep clear of the bed.

NOTE: Use AUTO COMPENSATION feature before adding or removing any items (e.g.: urine bags, iv poles, mattress pumps, bed-cloths etc.).

CAUTION:



The weighing system **MUST** be zeroed every time a new patient is to be placed on the bed.



The weighing system **MUST** be zeroed every time a mattress is changed.



The weighing system cannot be zeroed if a weight is more than mattress or accessories weight.

12. MAINTENANCE & CLEANING

Maintenance

Each time before putting the Bed into service the user must check that –

- All the functions are in satisfactory working condition before the Bed is allotted to the next patient.
- Unplug the mains supply before carrying out any maintenance activity.
- Lubrication of all the mechanical joints/pins / moving parts / tightening of the bolts should be carried out at least once in three months, to avoid unnecessary sound and wear & tear of the Bed.
- At regular intervals carry out a visual inspection and check for any mechanical damage (e.g. loose /missing rivets, Screws, etc.)
- If any damage or malfunction is observed, immediately report this matter to the operator.
- If the Bed is not in use, it should be stored in a dry and flat indoor environment which is rodent-free with a gradient, not more than 5 degrees.
- If the Bed is not in use for the long term, it is necessary to conduct a test to check for functioning and any electrical or mechanical damage that may have been caused.
- Depending on the usage, certain moving parts may require replacement due to wear & tear. We recommend timely replacement with genuine Midmark spares for safety and trouble-free operation.
- Lubricating the moving parts and tightening of the bolts should be carried out periodically.

Cleaning & Disinfecting –

- The Bed is not suitable for machine wash or steam cleaning.
- Do not use a water jet for cleaning.
- Always disconnect the mains power cord from the electrical power supply before cleaning.
- Wipe the electrical components with a dry cloth only. No traces of water or disinfectant should be present on any electrical component.
- The Bed cannot tolerate the influence of strong solvent, basic or alkaline liquids & caustic agents. Also, do not use concentrated insecticides on electrical parts.
- The cleaning agents must not contain any substances which bring about any change in the structure or adhesive property of the plastic.
- The Bed should be properly cleaned and disinfected to avoid infection and stains before allotment to a new patient.
- Immobilize the Bed & remove all the detachable accessories and components before cleaning. Any prolonged contact of urine or acid on mild steel can corrode the surface. Always keep the surface dry.
- Wearing suitable protective clothing, clean the surface with a disposable cloth soaked in a neutral detergent and hot water. We recommend the use of approved disinfectant and cleaning agents to clean the Bed. E.g. Bacillocid or other similar agents.
- Start by cleaning the upper sections of the Bed & work along all horizontal surfaces. Work methodically towards the lower sections of the Bed. Take extra care to clean areas that may trap dust or dirt. All detachable accessories and its component can be cleaned separately.



Do not expose the Bed to excessive moisture as corrosion may cause personal injury or equipment damage.

Disposal:



Product and its defective parts especially elements made of plastic, steel, rubber, and electrical /A electronics (including battery) material should be disposed of in accordance with the statutory rules and regulations prevailing for such disposal. The user is advised to contact 'Midmark India' for further assistance.

Routine Inspection Check List: Inspection by the User

(Recommended Frequency: Every new allotment but not later than one month)

Checks	Observations	OK	Not OK	Description of faults
Visual check of the electrical components				
Embedded Panel cables (Product specific)	Damage, loose, hanging			
Mains cable	Damage, loose, hanging			
Control elements, Attendant control panels inside Rails	Damage, loose, hanging			
Visual check of the mechanical components				
Mainframe	Damage deformation			
Patient lifting pole, locating sleeves	Damage, Bend			
Mattress	Damage			
Metal Top	Damage deformation			
Side Railing	Damage Position			
Railing Dampeners (Gas Springs)	Damage			
Counterbalance springs for backrest	Loose			
Screws And Rivet	Missing, Loose			
Performance check of the electrical components				
Embedded Panel (Product specific)	Function test			
Control unit	Function test			
Motors	Function test			
Night lamps	Function test			
Performance check of all mechanical components				
Detachable head and footboards	Secure retention			
Castors	Locking & release			
Emergency lowering of the backrest (CPR handle)	Function test			
Side railing	Engagement, release, secure fastening			
Lower Leg Section	Function test			
Accessories	Fastening, damage, missing			
Sign	Result of inspection		Date	

Troubleshooting Guide

PROBLEM	POSSIBLE CAUSES	REMEDY
Embedded Panel (Product specific) system not Functioning	<ul style="list-style-type: none"> • Main cables not plugged in • No main voltage at main supply/no current supply • Embedded panels/ handset cable not fixed properly to the control unit • Error in embedded panels unit 	<ul style="list-style-type: none"> • Plug in the main cable • Checking in the Supply Current • Fix in the embedded panel/handset • Replace the embedded panel unit
Certain function not working	<ul style="list-style-type: none"> • Actuators not functioning • Control unit not functioning • Embedded control panel not working • Cables of the actuators are loosened 	<ul style="list-style-type: none"> • Replace the actuators • Replace or repair the control unit • Replace or repair the embedded panel • Fix the cables firmly
Emergency operation not possible	<ul style="list-style-type: none"> • Battery rundown • Battery fuse blown off • Battery wire loosened 	<ul style="list-style-type: none"> • Recharge the battery as recommended • Replace the fuse • Fix the battery wire firmly
Beeping sound from the control unit	<ul style="list-style-type: none"> • Overload on the bed • Internal or external fuse blown off • Battery run down 	<ul style="list-style-type: none"> • Reduce the load on the battery • Replace the fuse • Recharge the battery
No functions are operating	<ul style="list-style-type: none"> • Main cable loosened • Error in control unit 	<ul style="list-style-type: none"> • Tighten the main cable firmly • Replace or repair the control unit
No function via embedded panel/handset	<ul style="list-style-type: none"> • Embedded panel/Handset is defective. 	<ul style="list-style-type: none"> • Replace or repair the embedded panel/Handset
Manual emergency operation not functioning	<ul style="list-style-type: none"> • Bowden cables are set with too much slack or have become unhooked • Breaking in the Bowden cable • Squeaking in Bowden cable 	<ul style="list-style-type: none"> • Readjust on release lever or adjust the wire by loosening the wire • Replace the Bowden cable • Lubricate the Bowden cable by oiling

--	--	--

13. WARRANTY & SERVICE

Midmark India Pvt. Ltd. warrants solely to the end-users of this EX7000 bed that for a period specified in the warranty certificate, such EX7000 bed shall perform as per its intended use. The foregoing warranties shall not apply if the Product has been subjected to:(a) physical abuse, misuse, abnormal use, or use not consistent with Midmark India Pvt. Ltd.'s published directions, (b) any modification by anyone other than Midmark India Pvt. Ltd., or third parties designated by Midmark India Pvt. Ltd., or (c) fraud, tampering, negligence, or accidents, depending upon the nature of the products.

Limitation Of Liability: In no event shall Midmark India Pvt. Ltd., be liable or obligated to the end-user in any manner for any special, non-compensatory, consequential, indirect, incidental, statutory, or punitive damages of any kind. Including, without limitation. For injury or loss of life, lost profits lost sales. Lost revenue, loss of any software or data. or loss of use of any hardware, software, or data, regardless of the form of action, whether in contract, tort, negligence, strict product liability, or otherwise, even if Midmark India Pvt. Ltd., has been informed of or is aware of the possibility of any such damages in advance. Midmark India Pvt. Ltd.'s total aggregate liability under this agreement and in relation to anything which Midmark India Pvt. Ltd., has done or not done in connection with this agreement shall be limited to the price of the products purchased and paid for by the end-user during the period in which such liability arises. The limitations set forth above shall be deemed to apply to the maximum extent permitted by applicable law and notwithstanding the failure of the essential purpose of any limited remedies.

To maintain functional safety and right to claim under the warranty only original 'Midmark' replacements parts may be used for ordering replacement parts, customer service request and further question, please contact our technical support department.

Disclaimer

Every effort has been made to ensure that the information in this user manual is valid. Midmark India Pvt. Ltd., reserves the right to change the information in this document without prior notice."

MANUFACTURER'S ADDRESS

Corporate Office:

Midmark India Pvt. Ltd.

Art Guild House, "A" Wing, Unit No.15 & 16, Lower Ground Floor, Phoenix Market City, LBS Road, Kurla(West), Mumbai, 400070

Toll Free: 1800 22 8020 | Tel: .:+91 22 4915 3000

Registered Office:

Midmark India Pvt. Ltd.

Janak House, Opp. IOC Depot, Shaikh Misry Road, Wadala (E), Mumbai – 400037, India

[Tel: + 91 22 2413 0407](tel:+912224130407)

Toll-Free No.: 1800 22 8020 | Email: technicalsupport@midmark.com



MIDMARK INDIA PVT LTD.

Art Guild House, A-Wing, Unit No. 15 & 16, Phoenix Market City, LBS Road, Kurla (W), Mumbai - 400 070 Toll Free: 1800 22 8020 | Tel: +91 22 4915 3000 | Fax: +91 22 4915 3100 www.midmark.in
| india@midmark.com