



BX2000 Plus Semi Fowler Bed

User's Manual

Index

1. Introduction	3
2. About this Product	3
3. Definitions	4
4. Safety	4
6. Environmental Specifications	5
7. Installation	7
8. Add-On Accessories	8
9. Operation	8
10. Maintenance & Cleaning	9
11. Warranty & Service	13

INTRODUCTION

About this User Manual

This user manual contains instructions for the proper and safe use of the BX2000 – Plus Semi Fowler Bed, and for patient & user safety and comfort, which has to be strictly followed.

This User Manual has to be read and followed by every person using or handling this BX2000 – Plus Semi Fowler Bed. In case of any query, kindly contact Midmark India Pvt. Ltd.

ABOUT THIS PRODUCT

- This bed is a non-invasive medical device used for resting and treatment of the patients by medical/paramedical / hospital personnel to help and support the patient in diagnosis, prevention, monitoring, treatment, or alleviation of the disease.
- This BX2000 Plus Semi Fowler Bed is patient support and patient rest facility, which helps medical experts in carrying out their medical procedures comfortably.
- This BX2000 Plus Semi Fowler Bed is operated without any electrical or electromechanically operated functions.
- This BX2000 Plus Semi Fowler Bed is manufactured and supplied in non-sterile conditions for use in a normal hospital environment.
- Use bed accessories in accordance with the manufacturer’s instructions for patient safety and comfort. Use recommended spares and accessories like safety side rails, saline rod, and mattress of suitable design manufactured by “Midmark” to eliminate hazards.
- The hospital bed is designed to be dismantled into sections for ease of transportation but can be easily assembled with a minimum of tools

BX2000 – Plus Semi Fowler Bed Features



Please refer BX2000 – Plus Semi Fowler Bed catalogue for salient features of this product.

BX2000 – Plus Semi Fowler Bed Technical Data



Please refer BX2000 – Plus Semi Fowler Bed catalogue for technical data of this product.

Add – On Accessories



Please refer BX2000 – Plus Semi Fowler Bed catalogue for various accessories available and compatible with this product

DEFINITIONS

Operator

The operator is the person appointed by the owner (i.e. clinic, hospital management. etc.) who will be responsible for the safe operation of this Bed.

User

A user is a person who is capable of assessing the clinical condition of the patient e.g. specialist medical personnel, doctors, nursing staff, attendants, etc. Based on their training experience or through the instructions, they are entitled to operate the Bed on their responsibility or to carry out work on it and can recognize and control possible risks to the patient as well as the Bed.

Patient

A patient is a person who is ill, infirm, disabled, or in need of care & occupying this Bed. Each time the Bed is allotted to a new patient it is recommended that the patient is instructed by the operator or the user about the functions important for his/her comfort and safety.

SAFETY

In this User Manual, the following safety symbols are used



Danger: This symbol will appear wherever safety instructions are designed to protect people from physical harm. The symbol stands for imminent danger of death or serious injury.



Caution: This symbol will appear where situations are described, which might be dangerous, and which might inflict slight injuries.



Advice: This symbol will appear in front of additional helpful pieces of advice.



A dot in front of the text implies the action that is required to be taken.

Safety Instructions

- Always use original accessories that have been designed and approved for use with the Bed.
- Ensure that the Bed is assembled and installed following the instructions given in this user manual.
- Restrict child visitors without proper attendants. Supervision is necessary to avoid any mishap due to unintended movement of the Bed.
- Persons with reduced physical or mental abilities & children must not be allowed to use & handle the Bed without proper supervision.
- To prevent the patient from falling, slipping, rolling off from the bed, or any unintended entrapment, periodically check patients for safe positioning in accordance with facility protocols.
- Do not allow any visitor to sit on the bed, as it may cause overloading (Refer section operation).
- Accessories or any devices used along with the Bed should be as per its intended use specified and approved by Midmark.
- Don't move the vacant bed in a vertical position or push on the floor, as this will damage the leveling & alignment of the hospital bed. To shift the bed. Lift the bed from the main frame on both the side and then move.
- The Bed should always be kept and used in normal indoor hospital environment.
- Always use a mattress of the correct size and type. Before operating the Bed, make sure that the patient is safely positioned to avoid entrapment or imbalance.
- Do not keep any articles on the Base Frame Cover of the Bed. It can damage the linkages and electrical components.
- Keep some gap between walls and bed while in a stationary position and also while moving from one place to another.
- Keep the user manual handy with the operator/user for ready reference.



The use of a water mattress on the bed is prohibited.



Please observe and follow the above safety instructions to avoid any injuries to patients, users, and attendants.

ENVIRONMENTAL SPECIFICATIONS

Usage, Storage and Transport

Temperature	-10° C to 50°C
Relative Humidity	0% to 95% non-condensing
Atmospheric Pressure	800 to 1060 hPa
Altitude	< 200Qm

INSTALLATION

1. Unpack all the components carefully.
2. If the packing is drenched by rain, water, or other liquids, inform this matter to the operator.
3. Each Bed is supplied with the following components as per the packing list:

• Mainframe with backrest screw mechanism	01 No
• Legs (As per customer order specifications)	02 Nos
• Head & Foot Boards (As per customer order specification)	02 Nos
• Polymer Moulded Handle	01 No
• Safety Side Rails (As per customer order)	01 Pair
• Mattress (As per customer order)	01 No
4. Fix the legs on the mainframe.
5. Place Head & Foot Boards on the mainframe.
6. Fix the Safety Side Rails in position.
7. Fix the optional accessories on the bed.
8. Demonstrate the functions of the bed to the user/operator.



Installation of the hospital bed should be done only by Midmark trained technicians.



Packing materials have to be disposed of according to the local regulations for waste disposal.



With due consideration to environmental limitation, materials used to make the device are not affected by contact with any biochemicals or biowaste when used as per its intended purpose, all materials used in the product and accessories do not facilitate breeding or growth of bio-contaminants on their own.

OPERATION

- Before putting the hospital bed into used for the first time, ensure all the transport securing devices and packing film are removed.
- Clean and disinfect the hospital bed prior to the first time use.
- The hospital bed should be used on a flat floor.
- Check, if all the adjustments are functioning properly.
- This hospital bed may only be operated by a person who has the knowledge of its operation.



Do not overload the bed above 135 Kgs, which is the safe working load of this bed (patient + Mattress).

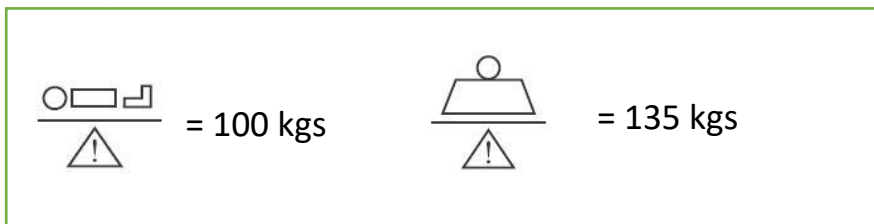

Backrest



For adjusting the backrest section, first, insert the handle (1) on the screw head (2) below the frame on the leg end of the bed, then rotate the handle anticlockwise to raise or clockwise to lower the backrest section (see Figure 1)

Do not turn the handle beyond its limits in any direction, as it may cause damage to the mechanism. Always remove the handle, when not in use or while transporting the bed. It may hurt people passing by or the handle can also be damaged.



Head and Foot Boards (Removable Type):



(0181E – MS Head & Foot Boards)



(0181 – Conventional Head & Foot Boards)



(0182G- SS Laminated
Head & Foot Boards)



(0182H – SS Head &
Foot Panels)



(0183 – Polymer
Moulded Panels)

Head Boards:

- The headboard is located at the head end of the bed frame
- The headboard can be removed or attached in a single step by extending equal force with both the hands in the backrest by ensuring the proper matching of the brackets with board holder fitted on the mainframe
- The headboard can be removed for the ease of access to the patient from head side

Foot Boards:

- The footboard is located at the foot end of the bed frame
- The footboard can be removed or attached in a single step by extending the equal force with both the hands in the bracket by ensuring the proper matching of the backrests with board holder fitted on the mainframe

 Do not hang any heavy items on the Head & Foot Boards

 Use the Bed accessories in accordance with the manufacturer's instructions for patient safety and comfort. Use recommended spares and accessories suitable design manufactured by "Midmark India Pvt. Ltd." to eliminate hazards.

Side Rails Options

Safety Side Rails





0355A- Collapsible Type Epoxy Powder Coated Vertical Safety Side Railing (Pair)

0355A- Collapsible Type Epoxy Powder Coated Vertical Safety Side Railing (Pair)

1. To lock the railing, pull up the railing with the hand till the plunger Lock (1) snaps into place in the Locking slot.
 2. To unlock the railings, pull out the plunger Lock (1) with one hand & hold the Railing with the other hand. Place the railing downward completely till it rests on the bed frame.
- Safety Side Rails should be properly fitted and secured by a trained technician.
 - Always use the Safety Side Rails with the mattress of the correct size. Which is approved for use with this bed for the safety of the patient.
 - Do not use the Safety Side Rails to move or lift the bed.

 Although the Safety Side Railings have been designed to reduce the risk of the patient injury, the potential exists for patient entrapment, particularly in agitated or disoriented patients, patients who have a cognitive disability or have uncontrolled body movement as well as patients who lack the physical strength to extract themselves, if they get entrapped.

 Users should carefully evaluate the need for safety side rails and periodically check patients in accordance with facility protocols for safe positioning.

 If these safety measures are not observed, injuries can be caused to hands, knees, fingers, feet, legs or other body parts of patient due to unintended and unintentional entrapment. In children or weak patients who are less than 146 cms tall, non-observance of these guidelines may even lead to death.

ADD ON ACCESSORIES

IV Pole:



IV Poles are used to hang IV bags for infusion of liquid substances directly into a vein. The IV pole is removable, telescopic pole that can be installed in any of the sockets located at four locations provided on the main frame of the bed. The IV Pole has a safe working load of 5 Kgs.

 Do not exceed the load capacity of the IV pole. If IV pole is overloaded, personal injury or equipment damage may occur.

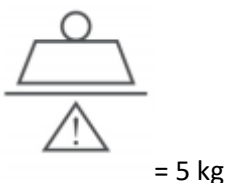

Mattress



Patient should not be put on the bed without the right mattress.



Midmark recommends the use of Midmark made mattresses that have been designed & tested specifically for the BX2000 Plus Semi Fowler bed. Also ensure that the dimensions & construction of the mattress should minimize the gaps where entrapment could occur, provide sufficient height between the mattress & the top of the side rail to prevent accidental rollover events, provide appropriate firmness at the edges of the mattress to facilitate safe transfers in & out of the bed & do not interfere with the proper operation of side rails.



Mattress impermeability could be affected by needle sticks. Users should be instructed to avoid punctures caused by improper use of needle sticks. Failure to do so could result in cross-infection & patient injury. The mattress should be regularly inspected for punctures, rips, tears, or other such damages & should be replaced with a suitable mattress if required.



Patients should not be allowed to smoke in bed as it may cause a fire hazard, and personal injury or equipment damage could occur. Mattress, sheets & pillows generally do not have flame retardant properties.

Urine Bag Holder



Urine bag holder is used to hang the urine bag. The urine bag can be placed on the hooks provided on the urine bag holder.

Castors with Rubber buffer



The Castors are intended for indoor use only. Outdoor use may cause temporary or permanent damage to the castors. The bed is designed to be moved on a smooth stepless floor through 1000 mm wide doorway.

Orthopaedic Traction Pulley

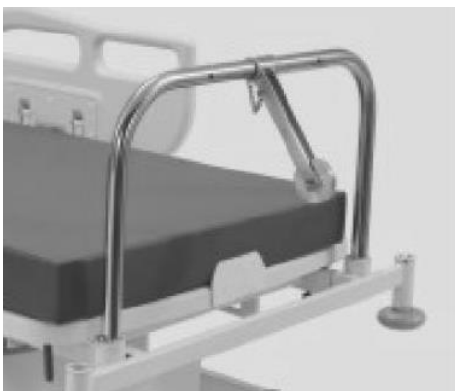

Used in orthopedic treatment for physical therapy

Moulded Chart Holder (0158A)



Used for keeping medical reports and charts



To prepare the bed for transport (without patient)-

- All fixed equipment's and accessories should be secured properly to the bed before transportation
- All detachable accessories should be safely removed from the bed before transportation.
- The safety side rails should be in the lowered position
- Unlock the brakes on the castors before moving the bed
- If the bed is not equipped with the castors, it should be lifted from its mainframe & transported from one place to another

MAINTENANCE & CLEANING

Each time before putting the bed into service the user must ensure that-

- All the functions are in satisfactory working condition before allotting the bed to the patient
- Lubrication of all mechanical joints/ pins/ moving parts/ tightening of the bolts should be carried out at least once in three months, to avoid unnecessary sound and wear & tear of the bed
- Visual inspection is carried out at regular intervals and check for any mechanical damage (e.g. loose/ missing rivets, screws, etc.)
- If any damage or malfunction is observed, transfer the patient to other bed and report this matter to the operator
- If the bed is not being used, it should be stored in a dry and flat indoor environment which is rodent-free with a gradient not more than 5 degrees
- If the bed is not in use for a long time, it is necessary to conduct a test to check for functioning and any mechanical damage that might have been caused
- Depending on the usage certain moving parts may require replacement due to wear & tear. We recommend timely replacement with genuine 'Midmark' spares for safety and trouble-free operation

Cleaning & Disinfecting-

- The bed should be properly cleaned and disinfected to avoid infection and stains before the bed is allotted to a new patient.
- Immobilize the bed & remove all the detachable accessories and components. Use suitable rubber or plastic sheet below the mattress to prevent dampness from coming in contact within the bed's support surface. Any prolonged contact of urine or acid on mild steel can corrode the surface. Keep the surface dry at all times.
- Wearing suitable protective clothing, clean all surfaces with a disposable cloth soaked in a neutral detergent and hot water. We recommended the use of Bacillocid to clean the bed.
- Start by cleaning the upper sections of the bed & work along all horizontal surfaces. Work methodically towards the lower sections of the bed Take extra care to clean areas that may trap dust or dirt. All detachable accessories and its components can be cleaned and separately.
- Do not expose the bed to excessive moisture as corrosion may cause personal injury or equipment damage.
- Do not use any steam cleaning device on the bed. The bed is not suitable for machine wash. Do not pour water on the bed or use high- pressure water jets for cleaning purposes.

Disposal

Product and its defective parts especially elements made of plastic, steel & rubber material should be disposed off in accordance with the statutory rules and regulations prevailing for such disposal of waste. The user is advised to contact 'Midmark for further assistance.

ROUTINE INSPECTION CHECKLIST: INSPECTIONS BY THE USER

(Recommended Frequency: Every new allotment but not later than three months)

Checks	Observation	OK	Not OK	Description of faults
Visual check of the mechanical components				
Bed Frame	Damage/Deformation			
Screw and rivets are tightened	Missing/ Loose			
Performance check of all mechanical components				
Detachable head and footboards accessories	Secure retention Fastening, Damage, Missing			
Sign	Result of inspection		Date	

TROUBLESHOOTING GUIDE

PROBLEM	POSSIBLE CAUSES	REMEDY
Backrest not operating	Obstruction/ Broken screw mechanisms	Replace the screw mechanism

WARRANTY & SERVICE

Midmark India Pvt. Ltd., warrants, solely to the end-users of this bed that for a period specified in the warranty certificate, such bed shall perform as per its intended use. The foregoing warranties shall not apply if the product has been subjected to: (a) physical abuse, misuse, abnormal use, or use not consistent with Midmark India Pvt. Ltd.'s published directions, (b) any modification by anyone other than Midmark India Pvt. Ltd. or third parties designated by Midmark India Pvt. Ltd., or (C) fraud, tampering, negligence, or accidents, depending upon the nature of the products.

Limitation of Liability: In no event, shall Midmark India Pvt. Ltd., be liable or obligated to the end-user in any manner for any special, non-compensatory, consequential, indirect, incidental, statutory or punitive damages of any kind, including, without limitation, for injury or loss of life, lost profits, lost sales, lost revenue, loss of any software or data, or loss of use of any hardware, software or data, regardless of the form of action, whether in contract, tort, negligence, strict product liability, or otherwise, even if Midmark India Pvt. Ltd. has been informed of or is aware of the possibility of any such damages in advance. Midmark India Pvt. Ltd.'s total aggregate liability under this agreement in relation to anything which Midmark India Pvt. Ltd., has done or not done in connection with this agreement shall be limited to the price of the products purchased and paid for by the end-user during the period in which such liability arises. The limitations set forth above shall be deemed to apply to the maximum extent permitted by applicable law and notwithstanding the failure of the essential purpose of any limited remedies.

In order to maintain functional safety and right to claim under the warranty only original 'Midmark' replacements parts must be used. For ordering replacements parts, customer service request and further question, please contact our technical support department.

Disclaimer

Every effort has been made to ensure that the information in this user manual is valid. Midmark India Pvt. Ltd., reserves the right to change the information in this document without prior notice.

MANUFACTURER'S ADDRESS

Corporate Office:

Midmark India Pvt. Ltd.
Art Guild House, "A" Wing, Unit No.15 & 16, Lower Ground Floor, Phoenix Market City, LBS Road, Kurla(West), Mumbai, 400070
Toll Free: 1800 22 8020 | Tel: .:+91 22 4915 3000

Registered Office:

Midmark India Pvt. Ltd.
Janak House, Opp. IOC Depot, Shaikh Misry Road, Wadala (E),
Mumbai – 400037, India
[Tel: + 91 22 2413 0407](tel:+912224130407)

Toll-Free No.: 1800 22 8020 | Email: technicalsupport@midmark.com



MIDMARK INDIA PVT LTD.

Art Guild House, A-Wing, Unit No. 15 & 16, Phoenix Market City, LBS Road, Kurla (W),
Mumbai - 400 070 Toll Free: 1800 22 8020 | Tel: +91 22 4915 3000 | Fax: +91 22 4915
3100 www.midmark.in | india@midmark.com